

TF-DVD1570

Please read this manual before connection and use.

English

Important Safety Instruction



WARNING: TO REDUCE THE RISK OF FIRE OR ELECTRIC SHOCK, DO NOT EXPOSE THIS APPLIANCE TO RAIN OF MOISTURE.



The lightning flash with arrowhead symbol, within an equilateral triangle, is intended to alert the user to the presence of uninsulated "dangerous voltage" within the product's enclosure that may be of sufficient magnitude to constitute a risk of electric to persons.



The exclamation point within an equilateral triangle is intended to alert the user to the presence of important operating and maintenance (servicing) instructions in the literature accompanying the appliance.

**IMPORTANT FOR LASER PRODUCTS
CLASS 1 LASER PRODUCT**

DANGER:

- Visible laser radiation when open and interlock failed or defeated. Avoid direct exposure to beam.

CAUTION:

- These servicing instructions are for use by qualified service personnel only. To reduce the risk of electric shock, do not perform any servicing other than that contained in the operating instructions unless you are qualified to do so. Refer to manual for servicing instructions.

FCC NOTICE:

- This equipment has been tested and found to comply with the limits for a Class B digital device.
- Pursuant with the FCC Rules, Part 15. These limits are designed to provide reasonable protection against harmful interference in a residential installation.
- This equipment generates, uses and can radiate radio frequency energy and if not installed and used in accordance with the instruction may cause harmful interference to radio communication.

POWER SUPPLY:

- Connect the supplied adapter to the backside of the DVD player in the slot marked "Power In".
- Plug the two-prong end of the power cord to an AC100-240V outlet. If you have difficulty inserting the plug, turn it over and reinsert it, if the unit will not be used for a long time, disconnect the plug from the outlet.

NOTE:

- Before plugging the power cord into an AC outlet, make sure that all the connections have been made.

Important Safety Instruction

1. Read these instructions.
2. Keep these instructions.
3. Heed all warnings.
4. Follow all instructions.
5. Do not use near water.
6. Clean only with dry cloth.
7. Do not block any ventilation openings. Maintain well ventilated conditions around the product. Do not put product on bed, sofa or anything that blocks ventilation. Install according to instructions.
8. Do not install near any heat sources such as radiators, heat registers, stoves, or other apparatus (including amplifiers) that produce heat.
9. Do not defeat the safety purpose of the polarized or grounding-type plug. A polarized plug has two blades with one wider than the other. If the provided plug does not fit into your outlet, consult an electrician for replacement of the obsolete outlet.
10. Protect the power cord from being walked on or pinched particularly at plugs, convenience receptacles, and the point where they exit from the apparatus.
11. Only use attachments/accessories specified by the manufacturer.
12. Use only with the cart, stand, tripod, bracket, or table specified by the manufacturer, or sold with the apparatus. When a cart is used, use caution when moving the cart/apparatus combination to avoid injury from tip-over.
13. Unplug this apparatus during lightning storms or when unused for long periods of time.
14. Refer all servicing to qualified service personnel. Servicing is required when the apparatus has been damaged in any way, such as power-supply cord or plug is damaged, liquid has been spilled or objects have fallen into the apparatus, the apparatus has been exposed to rain or moisture, does not operate normally, or has been dropped.
15. Apparatus shall not be exposed to dripping or splashing and no objects filled with liquids, such as vases, shall be placed on the apparatus.

Copyright Protection

Unauthorized copying, broadcasting, public performance, and lending of disks are prohibited. This product incorporates copyright protection technology that is protected by method claims of certain U.S. patents and other intellectual property rights owned by Macrovision Corporation and other rights owners. Use of this copyright protection technology must be authorized by Macrovision Corporation, and is intended for home and other limited viewing uses only unless otherwise authorized by Macrovision Corporation. Reverse engineering or disassembly is prohibited.

Table of Contents

Table Of Contents

Important Safety Instruction

Unpacking1

Main Features2

Disc Information3

Unit View4-5

Remote Control6-8

Cable Connections9

TV Function10-13

AC Function14-15

PC Function16-18

Play Operation19-20

Playback Functions21-22

DVD Setup23-26

LCD Setup for DVD27-28

Troubleshooting29

Specifications30

Unpacking

Please make sure the following items are included with your LCD TV/monitor. If any items are missing, contact your dealer.

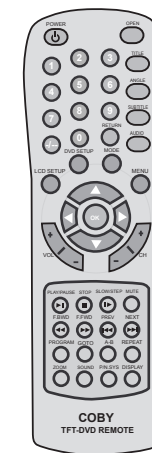

Remote Control

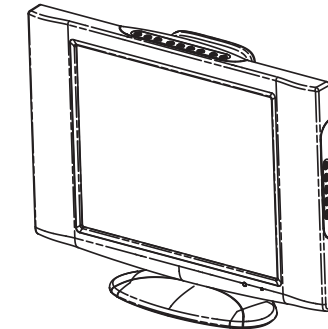

TFT-LCD

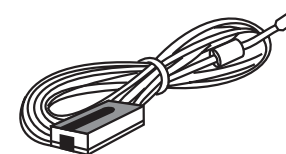

DC Adapter

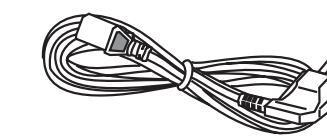

Power Cord

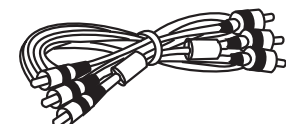

RCA Cable

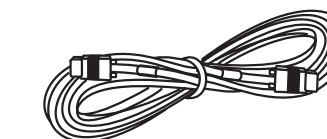

15-pin D-Sub Signal Cable (option)

Main Features

This product incorporates DVD player, LCD display and TV receiver in one system.

Multiple Mode

- DVD mode
- VGA mode
- VIDEO mode
- S-VIDEO mode
- TV mode
- COMPONENT mode

High Quality Property

High Resolution

Adopt an MPEG2 decoding format to achieve horizontal resolution more than 500 lines.

Superior sound

Built-in Dolby Digital decoder to output high quality sound effects.

Screen

Support the picture size of a normal screen (4:3).

Special playback

Support multi-angle, multi-language and multi-subtitle playback.

LCD (Liquid Crystal Display)

Designed with color TFT liquid crystal display clearly shows the data.

Stereo amplifier

Built-in 2x3w speakers.

Advanced Playing Features

Compatibility

DVD, CD, MP3, CD-R, CD-RW, JPEG discs compatible.

Zoom Function

Enlarge the picture to enhance your enjoyment.

All Playback Functions

Fast forward and reverse, repeat playback, program playback.

Search By Time

Ability to search disc contents via time code.

NOTE: It is normal for a TFT screen to experience some light or dark spots appearing on the LCD screen.

Disc Information

Discs Formats Supported By This Player

Disc mark	Contents	Size	Maximum playback time
DVD video discs	Audio+Video (moving picture)	12cm	133 min (SS-SL)
			242 min (SS-DL)
			266 min (DS-SL)
			484 min (DS-DL)
CD	Audio	12cm/8cm	74min/20min
MP3	Audio	12cm	600min
JPEG	Still high resolution		600min

The operating method of some DVD discs is specified by the software maker.

Please refer to the instruction manual of the disc.

The DVD Player will play most recordable (CD-R) or erasable (CD-RW) CDs, but playback of CD-R or CD-RW discs created on a computer requires proper formatting and finalization of the disc for audio playback. Some computers and/or software programs may not be capable of creating compatible discs.

About Disc Terms

Title

Generally, pictures or music compressed on a DVD are divided into several sections, "title".

Chapter

The smaller section unit of picture or music in a DVD under the title, usually one title is comprised of one or more chapters and each of them is numbered for easy searching. But some discs may not have a recording chapter.

Track

A segment of picture or music on a CD. Each track is numbered for searching.

Care of Disc

Video disc contains high-density compressed data that needs proper handling.

- Hold the disc with fingers by outer edge and/or the center spindle hole. Do not touch the disc surface.
- Do not bend or press the disc.



- Do not expose the disc to direct sunlight or heating sources. Store discs in cabinet vertically, and in dry condition. Prevent exposure to:
 - Direct sunlight
 - Heat or exhaust from a heating device
 - Extreme humidity

Clean the disc surface with a soft, dry cleaning cloth. Wipe the disc surface gently and radically from center toward the outer edge. Do not apply thinner, alcohol, chemical solvent, or sprays when cleaning. Such cleaning fluids will permanently damage the disc surface.

Unit View

Front/Top/Side Panel

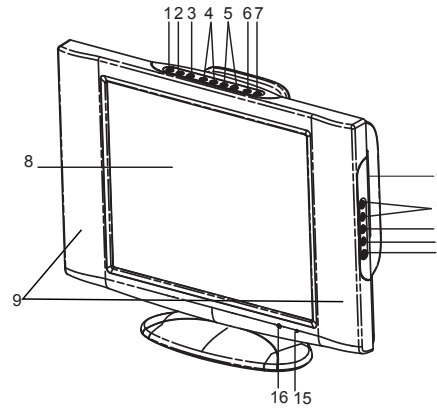

- MUTE button
Press to turn on/off the speaker output.
- ENTER button
- MENU button
The same function as the LCD SETUP button on the remote control.
- CH +/- button
Press to select channels backward/forward. While in TV mode, the same function as DOWN/UP direction button when in LCD menu set up.
- VOL +/- button
Press to decrease / increase the volume.
- MODE button
Press to shift modes among DVD, VGA, CATV, VIDEO, S-VIDEO, COMPONENT mode.
- POWER button
Press to access to or exit from the STANDBY mode.
- LCD Screen
Present high resolution pictures.
- Speakers
- Disc Loading Slot
Used for loading discs.
- PREV/NEXT Button
Press to skip backward /forward DVD chapter or CD track
- PLAY/PAUSE Button
Press it once to start playback. Press it twice to pause playing. Press it the third time to resume playback.
- STOP Button
Press the Stop button once to have a stop. It will start playing from where it is stop once PLAY/PAUSE button is pressed. Press the Stop button twice to have a stop. It will start playing from the beginning once PLAY/PAUSE button is pressed.
- EJECT button
Press to eject /take in the disc.
- Power On Indicator
In normal playback status, it turns green
- Remote sensor

Unit View

Rear Panel

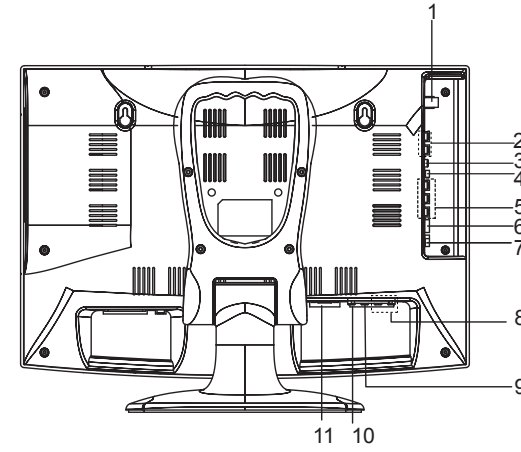

- Antenna in jack
Connected to external antenna to receive TV program in TV mode.
- L/R audio input jacks
Connection for external audio input under VIDEO, S-VIDEO or COMPONENT mode.
- Video input jack
Connection for external video input.
- PC Audio Input jack
Connection to the audio output jack on a personal computer.
- Y/Cb/Cr Component Video Input
- S-Video input jack
Connection for S-Video input.
- DC 12V power supply cord
- L/R audio output jacks
- Video output jack
- Coaxial digital audio jack
- VGA Input jack
Connection to the VGA output jack on a personal computer.

Remote Control

Remote Control Drawing

- POWER button
Press to access to or exit the STANDBY mode.
- Open button
Press to open or close the disc tray.
- TITLE button
When a DVD disc is playing, press to go to title menu if the disc contains.
- ANGLE button
Press to access various camera angles (if the DVD disc contains multiple camera angles).
- SUBTITLE button
When a DVD is playing, press to select a subtitle language (if the DVD disc contains multiple subtitles).
- AUDIO button
Press to access various audio languages (if the DVD disc contains multiple audio languages). Press to select Sound effect from STEREO/MONO under TV mode (if there is an ASP signal detected, the TV audio will turn to ASP mode automatically)
- MENU button
Press to access the disc menu during DVD playback.
- MODE button
Press to shift modes among DVD, VGA, VIDEO, S-VIDEO, TV, COMPONENT mode.
- DVD SETUP button
Press to access the DVD setup menu under DVD mode.
- LCD SETUP button
Press to access to LCD functional setup menu.
- DIRECTION BUTTON
Press to move cursor.
- OK button
Press to make confirmation
- NUMERIC KEY PAD
Select numbers by pressing these buttons.
- Channel button
Under TV mode press to chose channel. For example if you want to select channel 52, you can press the button twice repeatedly until OSD display --, and then input number buttons 5, 2.
- CH +/- BUTTON
Under TV mode, press to choose the channel.
- VOL +/- button
Press to increase or decrease the speaker volume level.
- Play/Pause button
Press to play/pause the disc under DVD mode.

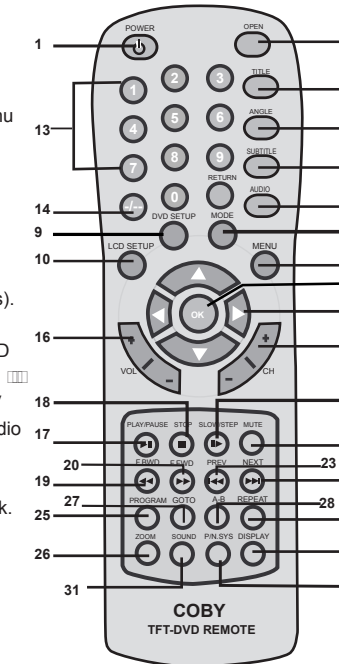

Remote Control

- Stop button
Press to stop playback, then press the PLAY button to resume normal playback.
- F.BWD Button
Press to search forward under DVD mode.
- F.FWD Button
Press to search backward under DVD mode.
- SLOW /STEP button
Press to activate slow forward or slow rewind or start step frame by frame under DVD mode.
- MUTE button
Press to turn on/off the speaker output.
- PREV Button
Press to skip to the previous chapter/track for some discs under DVD mode.
- NEXT Button
Press to skip to the next chapter/track for some discs under DVD mode.
- PROG button
Allows the player to play the contents in a programmed sequence under DVD mode.
- ZOOM button
When a DVD is playing, press this button to activate zoom function.
- GOTO Button
To search specified section of a DVD disc or a CD disc.
- A-B Button
Repeat certain portion of a performance
- REPEAT Button
Repeat a title ,chapter or track .
- DISPLAY Button
Press to show current playback status. To quit display mode, just keep on pressing until all the informations disappear from the screen.
- SOUND Button
Press sound button to adjust sound output mode
- P/N.SYS Button
Press to select NTSC or PAL system under DVD mode.

NOTE: Refer to playback function for detailed descriptions.

Remote Control

Remote Control

Preparation of Remote Control

- Take the back cover off of the remote control and insert two AAA batteries and put on the cover.
- Under normal use, the battery will last for six months.

Using of Remote control

Point the remote control unit from no more than about 7meter from the remote control sensor and within about 60 degrees of the front of the unit.

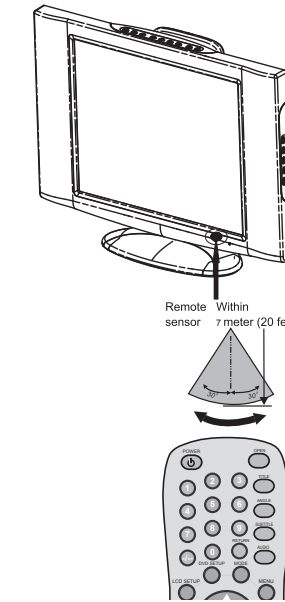

The operating distance may vary depending to the brightness around.

Notes:

- Do not point bright lights directly at the remote control sensor.
- Do not place objects between the remote control unit and the remote control sensor.
- Do not use this remote control unit while simultaneously operating the remote control unit of any other equipment.

Cable Connections

Figure. Cable connections

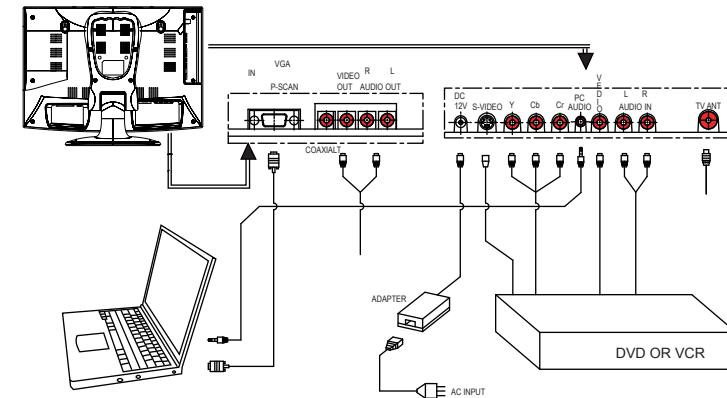

For your reference:

1. Connect TV RF sources to antenna port. TV RF signals include: receiving antenna/CATV net. You can use 75 Ω coaxial cable to connect outdoor antenna.
2. Connect the earpiece to the "phone" port.
3. Connect audio sources (including DVD/VCR/CAMCORDER/PC) to the proper audio input ports "L" and "R" by RCA cable.
4. Connect video sources (DVD/VCR/CAMCORDER) to the "VIDEO" or "S-VIDEO" port by RCA cable or S-VIDEO cable.
5. When used as computer screen, the PC port should be connected to computer display output by 15-pin D-SUB signal cable.
6. Insert the AC power to the DC adapter, then connect 12v input port of the Display to its' DC output port.

TV Function

TV Function

Preparations

1. Connect the antenna to the antenna jack on the unit side panel.
2. Connect the power supply cord. If the player is in standby mode, press the POWER button to turn on the power.
3. Press the MODE button to select the TV mode.
4. Press CH buttons on the remote control, or use the number buttons directly, to select the channel that you wish to view.

Picture Parameters setup

1. Press the LCD SETUP button once on remote control to access picture parameters setup menu, the screen will display as below:



2. Press up/down direction button, it appears in succession SYSTEM setup menu, FUNCTION setup menu, CHANNEL setup as well as EXTRA setup menu. Press OK button to confirm .
3. To exit the menu, press LCD SETUP button again, or press direction button to highlight the EXIT and then press OK to confirm

IMAGE Setup



1. Press up/down direction button to highlight the Image setup menu. And press OK to confirm .
2. Press up/down direction button to highlight the desired option from Contrast/Brightness/Saturation/Sharpness/Hue. Press OK to confirm.
3. Press left/right button to make adjustment. And press OK to confirm.
4. To exit the Image setup menu, highlight Exit and press OK to confirm.

NOTE: When in component mode, the Hue item is unavailable.

SYSTEM Setup

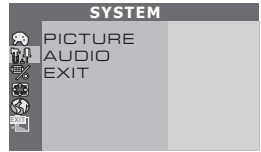

1. Press up/down direction button to highlight the System setup menu. And press OK to confirm.
2. Press up/down direction button to highlight the desired option from Picture/Audio. Press OK button to confirm.
Picture: Press up/down direction button to select the item from Dynamic/Normal/Soft. Press OK to confirm.
Audio: Press up/down direction button to select the item from Standard/Classic/Rock/Jazz/Pop. Press OK to confirm
3. To exit system setup menu, highlight EXIT and press OK button.

FUNCTION Setup

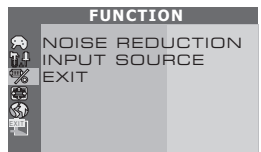

1. Press direction button to highlight the Function menu. And press OK button to confirm.
2. Press direction button to highlight the desired option from Noise Reduce/input Source, and press OK to confirm the selection.
Noise Reduction: press direction button to choose from ON/ OFF, and press OK to confirm. If ON is selected, the image will be shown clearly, but with unclear background. If OFF is selected, both image and background are displayed normally.
Input Source: a certain input mode has been tickled to indicate current situation. Press direction button to change the desired mode from DVD/VGA/VIDEO/S- VIDEO/TV/COMPONENT and press OK to confirm.
3. To exit function setup, highlight EXIT and press OK button.

TV Function

CHANNEL Setup

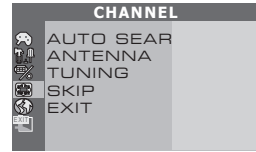

1. Press direction button to highlight the Channel setup menu. And press OK button to confirm .
2. Press direction button to highlight the desired option and press OK to confirm the selection. Refer to table 1 for detailed description.

(Table 1)

Item	Selection	Instruction
Auto Search	Press up/down direction button to highlight Search Press OK to start autosearch	Search the channels from low to high, and reserve the channels automatically. The reserved channel will be displayed on screen. Press OK to stop searching.
Antenna	Press up/down direction to select Air or Cable.	You can select an outer antenna or the cable TV
Tuning	Press right direction button to increase fine tune. Press left direction button to decrease fine tune.	In order to improve the picture and sound, you can use the function to adjust the received program, and then press OK to reserve it.
Skip	Press up/down direction button to select ON or OFF.	Set "ON" to skip the present program. It will not be displayed . To restore to normal , set it to "OFF"

NOTE: The program will be skipped when the signal is weak.

EXTRA Setup

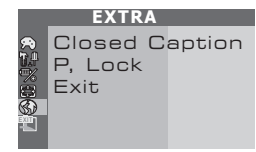

1. Press direction button highlight the Extra setup menu and press OK to confirm.
Closed Caption: if the Closed Caption is selected, press direction button to select an option : CC1 ↔ CC2 ↔ CC3 ↔ CC4 ↔ T1 ↔ T2 ↔ T3 ↔ T4 ↔ OFF
 If OFF is selected, the caption will be hidden.
NOTE:
 The Closed Caption operation is not allowed on some movies and TV programs.

TV Function

CHANNEL Setup

P. Lock: If the P. Lock is selected, input a 4-digit code to enter the P Lock menu. (Enter 1234 if it is the first use.) If the wrong code is input, the P. LOCK menu will not appear on screen.

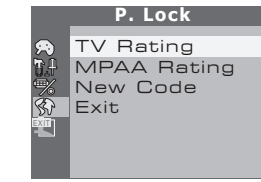

2. To exit the Extra setup menu press up/down direction button to highlight Exit, and press OK to confirm.

P Lock:

Some movies and TV programs include signals that classify the contents of the program. The P. Lock control feature in the TV detects the signal and blocks the programs according to your selections.

The default password to enter the system is 1234.

To change the password, please select the New Code item, and enter your desired 4-digit code.

Please keep a copy of it in a safe place. If the password is lost, the defaults setting will not be reverted to the original password.

There are two Rating systems: TV for broadcasters and MPAA for movies.

TV Rating TV-MA: Mature audience only TV-14: Not intended for ages under 14 TV-PG: Parental guidance suggested TV-G: General audience TV-Y7: For children age 7 and above. TV-Y: All children	MPAA Rating NR: Unrestricted X: For adults only NC17: Not intended for ages under 17 R: Restricted PG-13: Not intended for ages under 13 PG: Parental guidance suggested G: General audience
--	--

There are sub-categories within these ratings. As the rating increases, so does the intensity of the sub-category.

(I.e.) Under PG, V would be moderate violence. Under MA, V would be graphic violence.

D- Suggestive dialogue

L- Indecent language

S- Sexual situations

V- Violence

TV Function

AV Function

The player has AV functions. You can enjoy programs from external input sources such as recorder, vidicon, satellite receiver or game player etc.

Connect the external AV signal source to S-VIDEO or VIDEO jack, and then turn on the power of the unit, and press the MODE button to shift to the VIDEO / S-VIDEO /COMPONENT mode.

Picture Parameters setup (S-VIDEO/COMPONENT MODE)

1. Under the S-VIDEO or COMPONENT mode, press the LCD SETUP button once on remote control to access picture parameters setup menu, the screen will display as below:

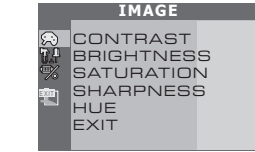

2. Press up/down direction button, it appears SYSTEM setup menu and FUNCTION setup menu.
3. To exit the menu, press LCD SETUP button again, or press direction button to highlight the EXIT and then press OK to confirm

IMAGE Setup



1. Press up/down direction button to highlight the Image setup menu. And press OK to confirm.
 2. Press up/down direction button to highlight the desired option and press OK to confirm.
 3. Press left/right button to make adjustment. And press OK to confirm.
 4. To exit the Image setup menu, highlight Exit and press OK to confirm.
- NOTE:** When in component mode, the Hue item is unavailable.

SYSTEM Setup

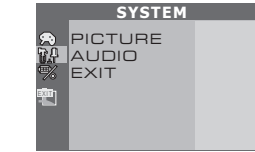

1. Press up/down direction button to highlight the System setup menu. And press OK to confirm.
2. Press up/down direction button to highlight the desired option and press OK to confirm.
Picture: Press up/down direction button to select the item from Dynamic/Normal/Soft. Press OK to confirm.
Audio: Press up/down direction button to select the item from Standard/Classic/Rock/Jazz/Pop. Press OK to confirm
3. To exit system setup menu, highlight EXIT and press OK button.

AV Function

FUNCTION Setup

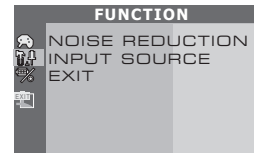

1. Press direction button to highlight the Function menu. And press OK button to confirm.
2. Press direction button to highlight the desired option from Noise Reduce/Input Source, and press OK to confirm the selection.

Noise Reduction: press direction button to chose option from ON/ OFF, and press OK to confirm. If ON is selected, the image will be shown clearly, but with unclear background. If OFF is selected, both image and background are displayed normally.

Input Source: a certain input mode has been marked to indicate current situation. Press direction button to change the desired mode and press OK to confirm.

3. To exit function setup, highlight EXIT and press OK button.

Picture Parameters setup (VIDEO MODE)

1. Under the VIDEO mode, press the LCD SETUP button once on remote control to access picture parameters setup menu, the screen will display as below:



2. Press up/down direction button, it appears SYSTEM setup menu, FUNCTION setup menu and EXTRA setup menu.
3. To exit the menu, press LCD SETUP button again, or press direction button to highlight the EXIT and then press OK to confirm

Refer to the section of "Picture Parameters setup (S-VIDEO/COMPONENT MODE)" of AV Function on page 14 for how to work with IMAGE setup menu, SYSTEM setup menu and FUNCTION setup menu

Refer to section of EXTRA SETUP of TV function on page 12, 13 for how to work with extra setup menu

PC Function

PC Function

You can use the unit's TFT LCD as your computer's monitor. Access the computer setup menu and take the steps shown as below:

1. Please turn off the power of the unit and the computer. Connect the unit to the computer VGA jack with the VGA cable.
2. Turn on power of this unit and the computer. If the unit is in standby mode, press the POWER button to switch on. Press the MODE button on the remote control to select the "VGA" mode.

Picture Parameters setup

1. Press the LCD SETUP button under the VGA mode to access picture parameters setup menu, the screen will display as below:

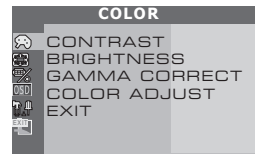

2. Press up/down direction button, it appears in succession IMAGE setup menu, FUNCTION setup menu, OSD Setup menu as well as MISCELLANEOUS setup menu.
3. To exit the menu, press LCD SETUP button again, or press direction button to highlight the EXIT and then press OK to confirm

COLOR Setup

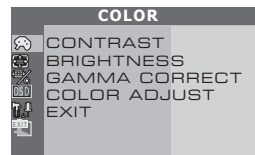

1. Press up/down direction button to highlight the COLOR setup menu. And press OK to confirm.
2. Press up/down direction button to highlight the desired option and press OK to confirm. See Table 2 as below for detailed descriptions.

Item	Adjust Range	Instruction
Contrast	0-100	Adjust the contrast to your satisfaction
Brightness	0-100	adjust the brightness to your satisfaction
Gamma Correct	4 grades (0,1,2,3)	Correct the brightness to your satisfaction
Color adjust	9300K: R (54), G(69), B (62) 6500K: R (59), G(62), B (49) User: R (0-100), G (0-100), B (0-100)	Adjust the color Temp to your satisfaction.

(Table 2)

PC Function

IMAGE Setup

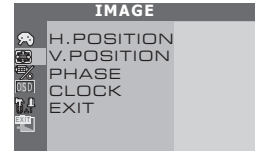

1. Press up/down direction button to highlight the IMAGE setup menu. And press OK to confirm.
2. Press up/down direction button to highlight the desired option and press OK to confirm. See Table 3 as below for detailed descriptions.

Item	Adjustment	Instruction
H.Position	Press left/right direction button to remove the position to left/right	Adjust the horizontal position to your satisfaction
V.Position	Press left/right direction button to remove the position to down/up	Adjust the vertical position to your satisfaction
Phase	Range from 0 to 100	Adjust the picture quality
Clock	Range from 0 to 100	Enlarge or reduce the display zone horizontally

(Table 3)

FUNCTION Setup

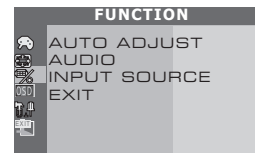

1. Press up/down direction button to highlight the FUNCTION setup menu. And press OK to confirm.
2. Press up/down direction button to select the desired item from Auto Adjust /audio /input Source. and press OK to confirm.

Auto Adjust : Adjust the horizontal and vertical position

Audio: Press up/down direction button to select the item from Standard/Classic/Rock /Jazz/Pop. And press OK to confirm.

Input Source: A certain input mode has been marked to indicate current status. Press direction button to change the mode from DVD VGA/VIDEO/S-VIDE/OE/TV/COMPONENT. And press OK to confirm.

PC Function

OSD SETUP

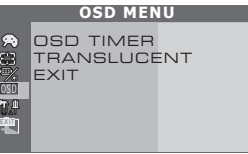

1. Press up/down direction button to highlight the OSD setup menu. And press OK to confirm.
2. Press up/down direction button to highlight the desired option and press OK to confirm. See Table 4 as below for detailed descriptions.

Item	Adjustment	Instruction
OSD Timer	Press up/down direction to select ON or OFF	When ON is selected, the OSD will automatically disappear after 8 seconds. When OFF is selected, the OSD can be closed just after selecting the Exit Submenu.
Translucent	Press up/down direction to select ON or OFF	When ON is selected, the OSD will be translucent.

(Table 4)

MISCELLANEOUS SETUP

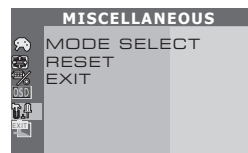

1. Press up/down direction button to highlight the OSD setup menu. And press OK to confirm.
2. Press up/down direction button to highlight the desired option and press OK to confirm. See Table 5 as below for detailed descriptions.

Item	Instruction
Model Select	Under the DOS mode, select resolution 640x400 or 720x400 for OSD
Reset	Select Reset to get to the factory setting.

(Table 5)

NOTE:

When the Reset function is activated, the initial settings for all models will be reset.

Play Operation

Play Operation

Preparation:

After all connections have been made, Press the POWER button to switch on the unit and then press MODE button to select DVD mode.

Under DVD mode, the following disc can be read by the player: DVD/ CD /MP3/ JPEG.

NOTE: To set the unit into standby mode, press the POWER button. In standby mode the unit is supplied with main voltage but not active. In this condition you can switch on the unit using the POWER button.

Disc Loading Steps:

1. Put the disc slightly into the disc tray.
2. The disc will be taken automatically into the tray. "read" will be highlighted on the screen and playback will begin.

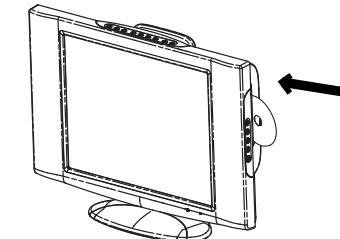

Warning: Do not play poor quality discs that may damage the player's lens.

DVD Playback

MENU

Normally there is a selecting menu for DVD discs. Press direction button to move to the desired item and press OK to confirm

During DVD playback, press menu button to get to the DVD start menu

TITLE & CHAPTER

Normally there are several titles in a DVD disc, and several chapters (sections) in a title.

AUDIO

Press the AUDIO button on the remote control to select a language for multi-language DVD disc. There can be up to 8 audio languages on a DVD disc.

Press the SUBTITLE button to select different subtitles for multi-subtitle disc.

ANGLE

Press the ANGLE button repeatedly until the desired perspective is shown. The movies on some DVDs have been recorded from various camera positions. This lets you enjoy the same scene from different perspectives. In this case you'll usually find a marking on the DVD sleeve.

VOLUME

During playback, press the VOL+ button to increase the volume and press the VOL- button to decrease the volume.

Play Operation

CD Playback

The player will play all tracks on a CD disc by default.

MP3 Playback

1. Load a MP3 disc into the disc tray.
2. Press the direction button to select the folder, use the OK button to enter it.
3. Press the direction button to select the track, press the OK or the PLAY/PAUSE button for playback.
4. Press the STOP button to stop playback. Press it once to have a stop, it will resume from where it was stopped. Press it twice to have a stop, it will resume from the beginning.

JPEG Playback

JPEG is a common picture format that requires small amounts of storage per image and has low loss in resolution. Hundreds of pictures can be stored on a disc in this format. In order to view JPEG photo albums, you can ask your film development company to make a "PICTURE CD" when they develop your film.

Normal Playback

1. Load a JPEG disc in.
2. Press up/down direction button to select a submenu and press OK to confirm
3. Press the up/down direction button to select the contents. Many discs have other contents besides pictures.

Picture Rotation

This can be used only when the picture is normally displayed. Once another picture is selected, rotation will be cancelled automatically.

There are four kinds of rotational modes: Inversion, Enantiomorphism, rotate left and rotate right. You can use direction buttons to select:

"UP" ----- Inversion/Normal

"DOWN" ----- Enantiomorphism/Normal

"LEFT" ----- Rotate left

"RIGHT" ----- Rotate right

Zoom and Move of Picture

The ZOOM button is used to turn on/off the zoom function and the move function.

During zooming status, you can use the direction buttons to move the picture.

During playback, press the STOP button to return to the previous menu.

NOTE: Depending on how the disc was made, a JPEG disc may allow playback, but not rotation or zooming of the images.

Playback Function

Playback Functions

Start playing

Press PLAY/PAUSE button once to start playing.

Pause playing

During playback, press the PLAY/PAUSE button once to have a pause. Press it twice to resume.

Stop playing

Press the STOP button once to stop playback. It will start playback from where it was stopped once PLAY/PAUSE button is pressed. Press the STOP button twice to stop playback. It will start playback from the beginning once PLAY/PAUSE button is pressed.

Repeat Function

- Use the REPEAT button to perform repeat function.
 - For DVD : REP: CHAPTER - REP:TITLE - REP:OFF
 - For CD : REP:1 - REP:ALL - REP:OFF
- Use the A-B button on the remote control to repeat a section A to B. The player can repeat any section A-B. Press once to set the starting point A, the second time to set the ending point B, and the third time to cancel repeat.

NOTE: Some discs do not support the repeat function.

Search Function

You can use the GOTO button on the remote control to get to the desired section. Press the GOTO button, below picture appears on the screen

DVD

Search by title /chapter

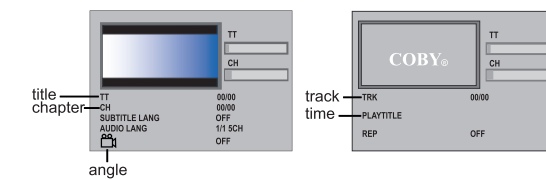

- Press the direction buttons to highlight item and press OK button to confirm
- Use the number buttons to input the title/chapter/track/time (hour, minute, and second) and then press OK button. The player will play specified section of a DVD or CD
- Press the GOTO button once again to exit from the preview window and menu.

NOTE: Some DVD discs do not support the search function.

Fast Playback

Press the FWD/F.BWD button on the remote control to activate fast forward or rewind. Repeatedly press the button will increase or decrease the search speed



Playback Function

Slow Playback

Press the SLOW/STEP button to play at slow motion. Repeatedly pressing the button will decrease the slow speed. * There is no slow playback for MP3, CD discs.

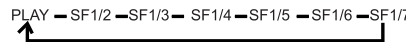

Zoom Function

Use the ZOOM button on the remote control to achieve several zoom effects. Press the ZOOM button once to achieve the following zoom sequence:

ZOOM 2 - ZOOM3 - ZOOM 4 - ZOOM1/2 - ZOOM1/3 - ZOOM1/4 - ZOOM:OFF

NOTE: There is no zoom function for MP3 or CD discs.

Sound

Press sound button to adjust sound output mode. Four items are available for adjustment : SRND, EQ, BAND, KEY.

Programming Chapters / Tracks

You can store up to 16 chapters of a DVD (or 16 tracks of a CD) in an individually programmed order. Please proceed accordingly:

- Press the PROGRAM button. The screen shows:

DVD

PROG	T C	T C	T C	T C			
1	---	5	---	9	---	13	---
2	---	6	---	10	---	14	---
3	---	7	---	11	---	15	---
4	---	8	---	12	---	16	---

PLAY CLEAR

CD

PROG	1	5	9	13			
1	----	5	----	9	----	13	----
2	----	6	----	10	----	14	----
3	----	7	----	11	----	15	----
4	----	8	----	12	----	16	----

PLAY CLEAR

- Use the direction buttons to select the sequence number, then use the number buttons to input the title/chapter/track number.
- Press the direction buttons to move cursor to the "Play" and then press the OK button to start programming playback.
- To clear all input, select the CLEAR and then press OK button.
- Press the PROG button again to exit.

DVD Setup

SETUP MENU

You can change the default settings to your own preference.

- Press MODE button to select DVD mode
- Press DVD SETUP button, System setup menu appears as default. And then press left/right direction button, it appears in succession Language Setup, Video Setup, Audio Setup and Digital Setup.
- Press up/down direction button to highlight the desired submenu and then press right direction button or OK button to confirm.
- Press up/down direction button to make selection in a selected submenu and press OK to confirm.
- To exit, press DVD SETUP again or select EXIT by direction button and then press OK button

SYSTEM SETUP

SYSTEM SETUP
TV SYSTEM
SCREEN SAVER
TV TYPE
PASSWORD
RATING
DEFAULT
EXIT

1. TV System

Select the TV System from NTSC/PAL/AUTO. The default setting is NTSC. (The TV System for north America is NTSC. Auto should only be used if you have a Multi-System TV.)

2. Screen Saver

Shift between Screen Saver ON and OFF. The default setting is On. The screen saver is useful to prevent your display from becoming damaged. If the Screen Saver is set ON, the screen saver picture appears when you leave the player in stop mode for about a few minutes. Press any button on main unit or remote control to exit from the screen saver.

3. TV Type

Select aspect ratio from 4:3 PS (Pan Scan); 4:3 LB (Letter Box); 16:9 (Wide Screen).
 4:3 LB (Letter Box): This is selected when the unit is connected to a normal TV. Wide-screen images are shown on screen, with black belt on the top and bottom.
 4:3 PS (Pan Scan): This is selected when the unit is connected to a normal TV. Wide-screen images are shown on screen, with some parts cut automatically.

4. Rating

There are eight levels of Parental Control. Level one opens discs to people of all ages. Level eight is suitable only for adults. To change the parental control setting, a 4-digit code is required to be input first. (The default code is 8888.) When the input code is confirmed, the level setting menu will appear. Select the appropriate level by the UP/DOWN button, and press OK button to confirm.

5. Password

Move the cursor to the PASSWORD prompt and press OK button. Input the password 8888 if it is the first use. After confirmation, you will be required to input a new 4-digit code, and verify again.

6. Default

This function allows you to change the player back to the factory default settings.

DVD Setup

LANGUAGE SETUP

Setup language for OSD/Menu/Audio/Subtitle.

LANGUAGE SETUP
OSD LANGUAGE
AUDIO LANG
SUBTITLE LANG
MENU LANG
EXIT SETUP

- Press Left/Right direction button to move cursor to LANGUAGE SETUP menu.
- Press up/down direction button to highlight the desired submenu and press right direction button or OK button to confirm.
- Press use up/down direction button to make selection.
- To exit, press DVD SETUP button again or move cursor to EXIT SETUP and then press OK button.

OSD LANGUAGE SETUP

LANGUAGE SETUP
OSD LANGUAGE
AUDIO LANG
SUBTITLE LANG
MENU LANG
EXIT SETUP

Default setting is ENGLISH

AUDIO LANGUAGE SETUP

LANGUAGE SETUP
OSD LANGUAGE
AUDIO LANG
SUBTITLE LANG
MENU LANG
EXIT SETUP

Default setting is ENGLISH

SUBTITLE LANGUAGE SETUP

LANGUAGE SETUP
OSD LANGUAGE
AUDIO LANG
SUBTITLE LANG
MENU LANG
EXIT SETUP

Default setting is ENGLISH

MENU LANGUAGE SETUP

LANGUAGE SETUP
OSD LANGUAGE
AUDIO LANG
SUBTITLE LANG
MENU LANG
EXIT SETUP

Default setting is ENGLISH

DVD Setup

AUDIO SETUP

Select audio out from SPDIF/PCM, SPDIF/RAW.

- Press left/right direction button to select AUDIO SETUP menu
- Press up/down direction button to select AUDIO OUT and press right direction button or OK button to confirm.

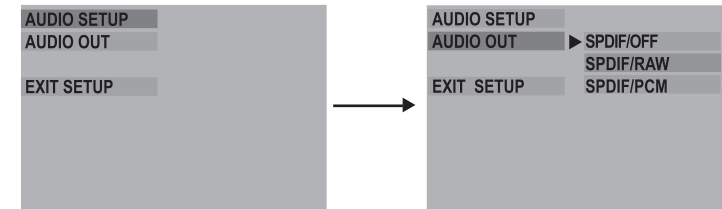

The default setting is SPDIF/RAW.

NOTE: When Digital Out is NOT in use, it is recommended to turn OFF the digital output setting, for the purpose of minimizing the circuit interference.

SPDIF/RAW: When this item is selected, all digital coaxial and optical outputs are turned on and are able to output a Dolby Digital signal.

NOTE: In order to output a Dolby Digital signal, the amplifier or external device that the unit is hooked up to must have Dolby Digital, DTS and MPEG decoding.

SPDIF/PCM: Select this item when the DVD player is connected with a 2-channel digital stereo amplifier. When a Dolby Digital or MPEG disc is played, the digital port will output in PCM 2-channel format.

SPDIF/OFF: When this item is selected, all digital coaxial and optical outputs are turned off.

VIDEO SETUP

Adjust brightness/ contrast/ hue /saturation

- Press left/right direction button to select VIDEO SETUP menu
- Press up/down direction button to select a submenu and press right direction button or OK button to confirm.
- Press up/down direction button to make adjustment and press OK to confirm.

For example, to adjust BRIGHTNESS:

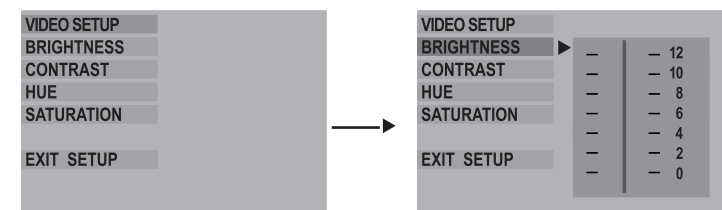

DIGITAL SETUP

Setup OP MODE, DYNAMIC RANGE, DUAL MONO.

DVD Setup

DIGITAL SETUP

Setup OP MODE, DYNAMIC RANGE, DUAL MONO.

- Press left/right direction button to select DIGITAL SETUP menu
- Press up/down direction button to select a submenu and press right direction button or OK button to confirm.
- Press up/down direction button to make selection and press OK to confirm.

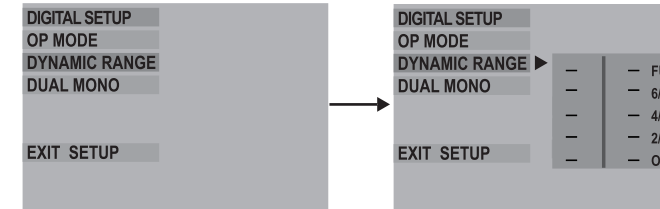
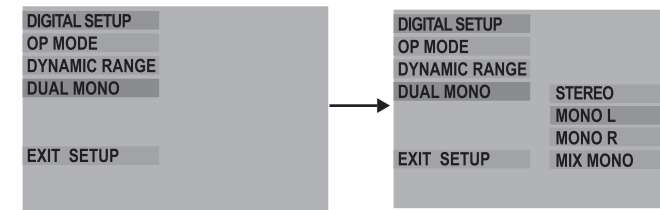
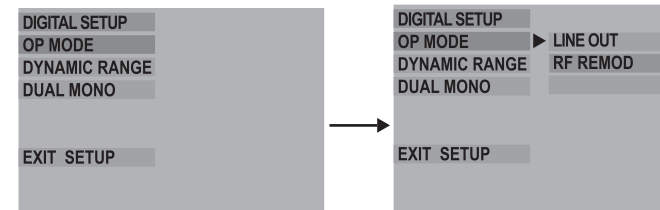

LCD Setup for DVD

LCD SETUP

Under the DVD mode, press the LCD SETUP button once on remote control to access picture parameters setup menu, the screen will display as below:

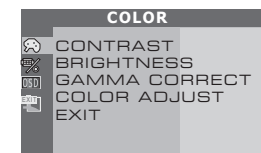

1. Press up/down direction button, it appears FUNCTION setup menu, and OSD MENU. Press OK button to confirm.
2. To exit the menu, press LCD SETUP button again, or press direction button to highlight the EXIT and then press OK to confirm.

COLOR Setup



1. Press up/down direction button to highlight the COLOR setup menu. And press OK to confirm.
2. Press up/down direction button to highlight the desired option and press OK to confirm. Refer to below table for detailed descriptions.

Item	Adjust Range	Instruction
Contrast	0-100	Adjust the contrast to your satisfaction
Brightness	0-100	Adjust the brightness to your satisfaction
Gamma Correct	4 grades (0,1,2,3)	Correct the brightness to your satisfaction
Color adjust	9300K: R (54), G(69), B (62) 6500K: R (59), G(62), B (49) User: R (0-100), G (0-100), B (0-100)	Adjust the color Temp to your satisfaction.

LCD Setup for DVD

FUNCTION Setup

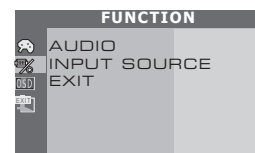

1. Press direction button to highlight the Function menu. And press OK button to confirm.
2. Press direction button to highlight the desired option from Noise Reduce/Input Source, and press OK to confirm the selection.
 - Noise Reduction:** press direction button to choose from ON/ OFF, and press OK to confirm. If ON is selected, the image will be shown clearly, but with unclear background. If OFF is selected, both image and background are displayed normally.
 - Input Source:** a certain input mode has been marked to indicate current situation. Press direction button to change the desired mode from DVD/VGA/VIDEO/S- VIDEO/TV/COMPONENT and press OK to confirm.
3. To exit function setup, highlight EXIT and press OK button.

OSD SETUP

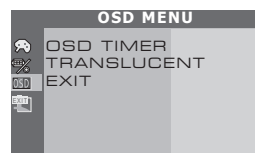

1. Press up/down direction button to highlight the OSD setup menu. And press OK to confirm.
2. Press up/down direction button to highlight the desired option and press OK to confirm. See Table 4 as below for detailed descriptions.

Item	Adjustment	Instruction
OSD Timer	Press up/down direction to select ON or OFF	When ON is selected, the OSD will automatically disappear after 8 seconds. When OFF is selected, the OSD can be closed just after selecting the Exit Submenu.
Translucent	Press up/down direction to select ON or OFF	When ON is selected, the OSD will be translucent.

Trouble Shooting

Symptom	Check and Action
No power	<ul style="list-style-type: none"> • Make sure the unit has been powered on manually. • Check if the power cord has been properly connected to the power outlet. • Check if the main power has been switched on.
No picture	<ul style="list-style-type: none"> • Try another TV channel • Check if the system connection is proper and secure. • Check if the connection cables are damaged.
No sound	<ul style="list-style-type: none"> • Increase the volume. • Check if the MUTE function of the unit has been activated. • Check if the sound system has been properly set. • Check if the AV audio signal input cable has been connected properly.
Color distorted	<ul style="list-style-type: none"> • Reset the color system of the unit. • Check if the system has been properly connected. • Check if the AV video signal input cable is connected properly.
Picture and sound are interfered	<ul style="list-style-type: none"> • Check if the system has been properly connected. • If using antenna, adjust the antenna.
Remote control does not work	<ul style="list-style-type: none"> • Make sure the POWER button on the unit has been turned on manually. • Remove the obstacles between the remote control and the player. • Point the remote control towards the remote sensor on the player. • Check if the batteries of the remote control have been loaded with correct polarities. • Replace the batteries of the remote control.
Screen is traverse interfered under PC mode	<ul style="list-style-type: none"> • Correct the phase setting in PC mode.
Malfunction	<ul style="list-style-type: none"> • Should the player develop a malfunction, unplug the player for 30 minutes. After that, power on the player and the restore function should reset the player.

Specification

TFT Panel characteristic	Size	15"	
	Resolution	1286x1024	
	Pixel pitch	0.264mm	
	TV system	NTSC 3.58/4.43 (VIDEO IN)	
	Tuning system	FS with PLL	
Standard	AC/DC Adapter	AC input	100-240V 50/60Hz
		DC output	+12V 5A
	Power consumption	On working	35W (Max)
		Standing	<2W
		Speaker	2x (4 Ω, 3.5W)
	Operating temperature range	10 ° c-40 ° c	
Dimension	506x155x393 mm		
Weight	5302g		